

1. Print on cardstock
2. Cut on the solid line
3. Fold on the dotted lines (see guide)
4. Apply tape to the front & back

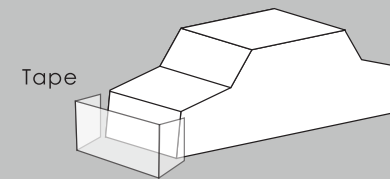

**REPEAT AS DESIRED!**

**COLOR YOUR OWN!**

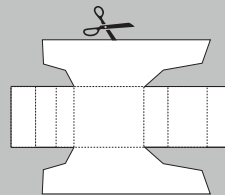
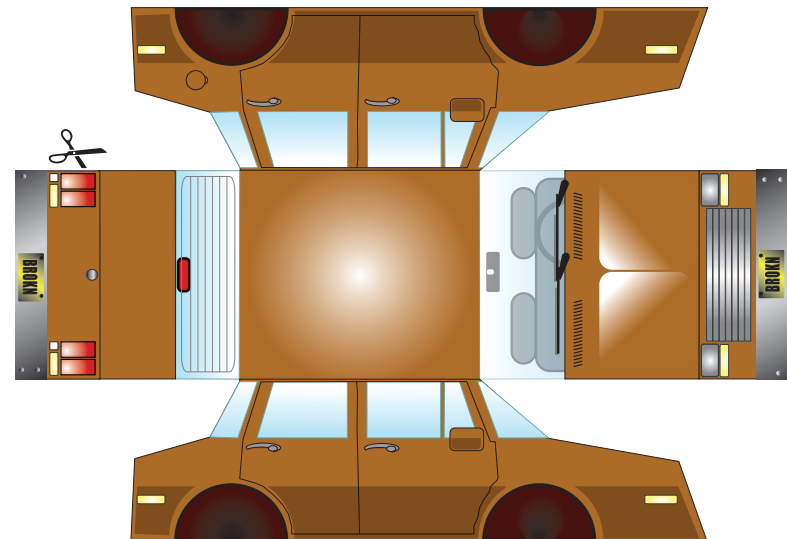
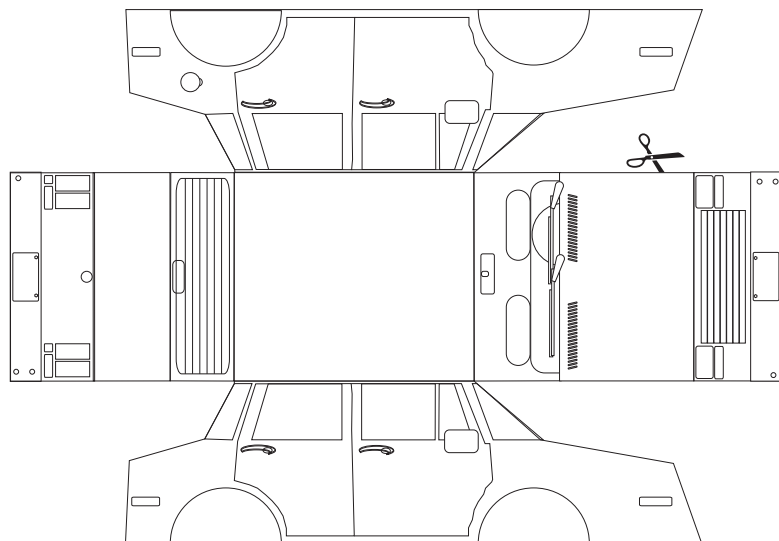

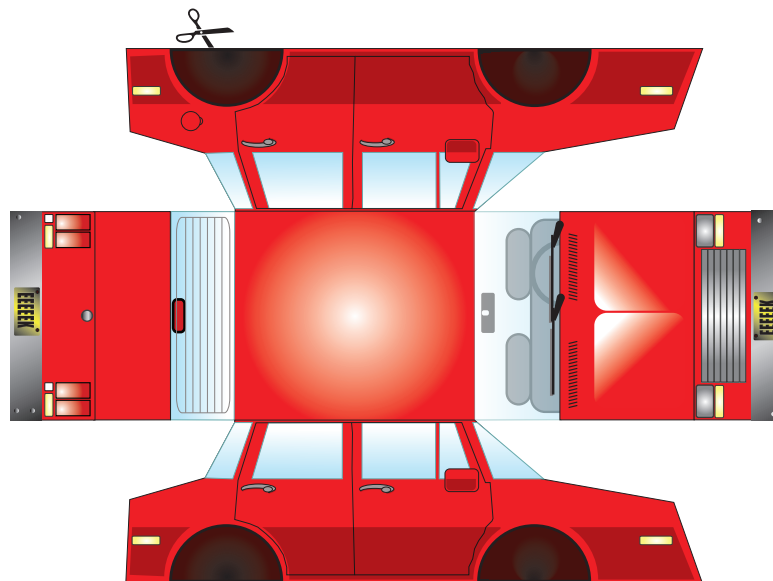
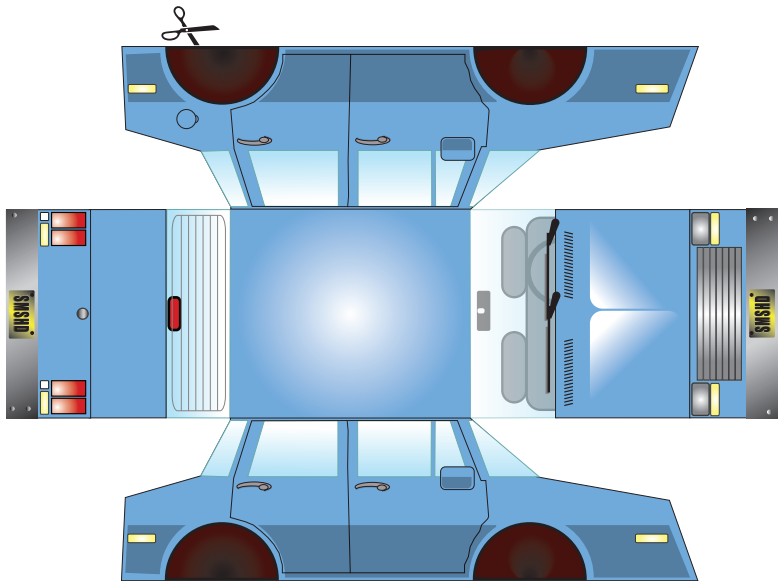

1. Print on cardstock
2. Cut on the solid line
3. Fold on the dotted lines (see guide)
4. Apply tape to the front & back

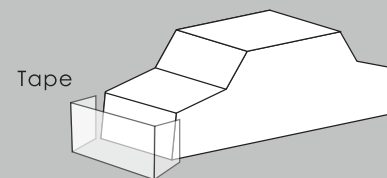
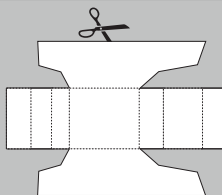

**REPEAT AS DESIRED!**

